

LIST OF MATERIALS			
ITEM	CODE	DESCRIPTION	QUANTITY
1	OX-R6942/OX-R7003	Kit Zeta clamp	24
2	OX-R6992	Kit L-lock	24
3	OX-R6991	Kit L-foot 105x50	24
4	OX-R6970	Rail Omnia 1.15mt	12
5	OX-R6970	Rail Omnia 0.20mt	12
6	OX-R6980	Riel Runner 2.32mt	6
7	OX-R8040	L-ANGLE	4
8	01	Zapatas de Concreto	Variable

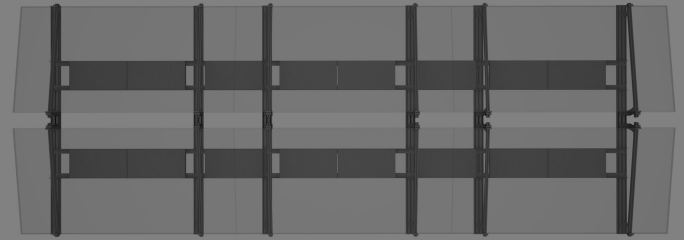

TOP VIEW

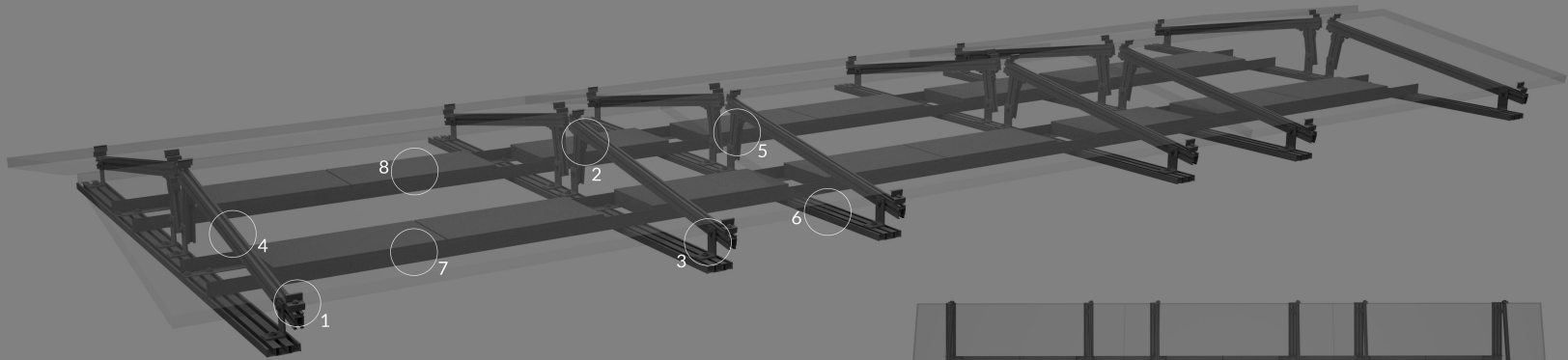

FRONT VIEW

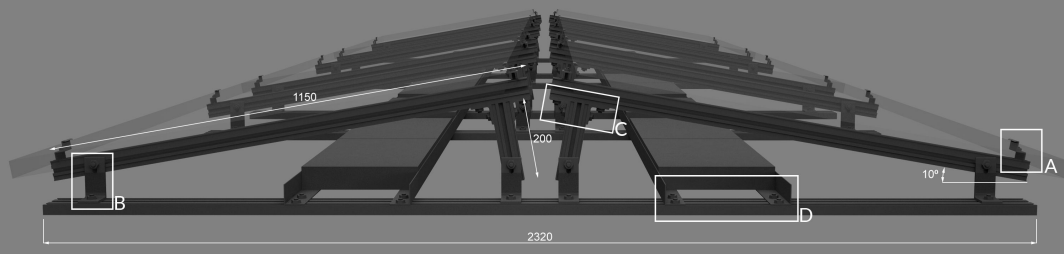

LEFT VIEW

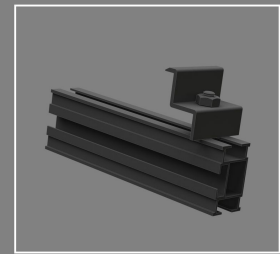

DETAIL A

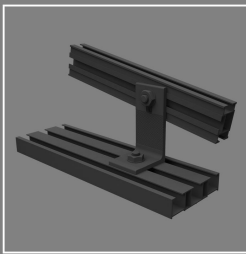

DETAIL B

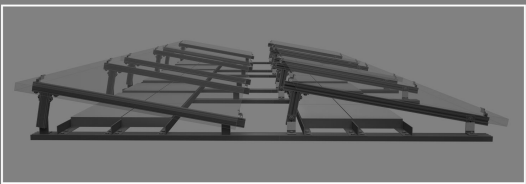

ONE-WAY OPTION



DETAIL C

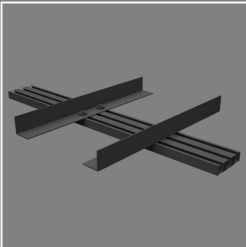

DETAIL D

01	10-01-2022	EL							DATASHEET UPDATE																								
REV	REV DATE	DRWN	APVD	APVD	CHANGE NUMBER				DESCRIPTION																								
UNITS: CENTIMETERS																																	
DO NOT SCALE																																	
THIRD ANGLE PROJECTION																																	
<b>TOLERANCES</b> UNLESS NOTED .XX ± .01 .XXX ± .005 X / XX ± 1 / 32 ANGLES 2°																																	
CONFIDENTIAL THIS DRAWING IS THE EXCLUSIVE PROPERTY OF RALUX LINE PRODUCTS COMPANY AND IS TO BE USED ONLY WITH THE PRIOR EXPRESSED PERMISSION OF RALUX SOLAR																																	
(PRODUCTION DRAWING TITLE) RALUX EAST / WEST LARGO 10° INCLINATION																																	
<table border="1"> <tr> <th colspan="2">QUALITY PLAN</th> <th>APDV:</th> <th>DATE:</th> <th>PART NUMBER</th> <th>DRAWING NUMBER</th> </tr> <tr> <td>QTY:</td> <td>LABEL:</td> <td>APDV:</td> <td>DATE:</td> <td>241222</td> <td>241222</td> </tr> <tr> <td>0</td> <td>CRITICAL DIMENSION</td> <td>APDV:</td> <td>DATE:</td> <td></td> <td></td> </tr> <tr> <td>0</td> <td>VISUAL INSPECTION</td> <td>APDV:</td> <td>DATE:</td> <td>SCALE: X:XXX</td> <td>SHEET NO: 1 OF 1</td> </tr> </table>										QUALITY PLAN		APDV:	DATE:	PART NUMBER	DRAWING NUMBER	QTY:	LABEL:	APDV:	DATE:	241222	241222	0	CRITICAL DIMENSION	APDV:	DATE:			0	VISUAL INSPECTION	APDV:	DATE:	SCALE: X:XXX	SHEET NO: 1 OF 1
QUALITY PLAN		APDV:	DATE:	PART NUMBER	DRAWING NUMBER																												
QTY:	LABEL:	APDV:	DATE:	241222	241222																												
0	CRITICAL DIMENSION	APDV:	DATE:																														
0	VISUAL INSPECTION	APDV:	DATE:	SCALE: X:XXX	SHEET NO: 1 OF 1																												
SHEET SIDE: 0 THIS DRAWING IS RALUX RACKING SYSTEM PROPERTY AND IT CAN'T BE COPIED OR TRANSMITTED TO ANYONE AUTHORIZATION																																	